

WinDoor®

HIGH PERFORMANCE DOORS & WINDOWS

7000 Series

Sliding Glass Door Aluminum

Featuring: 2 - 3 & 4 Track Sliding Glass Door Systems

Unlimited Number Of Panel Configurations available in Pocket, Bypass Systems



7000 Series Impact & Non-Impact

Sliding Glass Door Design Pressures

5'0 x 8'2- inches High Door

DP's Up To +75 / -75

H.P. Series

4'0 x 8'2- inches High Door

DP's Up To +80 / -90

Water Performance up to 11.2 lbs

Single or Double Glazed Options

U-Factor as Low as 0.60

SHGC as Low as .21



The Perfect Sliding Glass Door for Residential or Commercial Projects...

More Highlights On The Back

www.WinDoorInc.com



Handles: The EURO Handle System is a Standard Metal full-size interior and exterior handle that is available in a variety of colors. Featuring a large easy to operate pull handle.

Locking Systems Anti-Slam:

Adjustable stainless steel dual-point mortise locks...
Secondary locking system available, exterior key lock available as well.



Panels: have a depth of 1-5/16" with 4" wide stiles and rails.

7000 Series Non-Impact & Impact-Resistant Glazing: Featuring Hurricane Or Safety Protection Glass. Large and Small Missile Non-Impact Glazing: Tempered glass 3/16" & 1/4" and 3/4" tempered insulated glass for locations not requiring impact glazing. Impact-Resistant Glazing: Large missile - 7/16" & 9/16" single glazed and 3/4" tempered insulated glass. Protects against damage caused by windborne debris and intruders, and greatly reduces sound transmission. Eliminates the need for unsightly and inconvenient storm shutters. We call it... Passive Protection 24/7

Dual Fin-Seal Weather-stripping: Two sets of polypropylene fiber weather stripping concealed in panel perimeters. Keeps the elements out and reduces energy costs year after year.

Standard Roller Systems: True Coastal Hardware Locking Hardware and Rollers: Standard Stainless Steel housed adjustable tandem rollers with 1-5/8" Delrin® wheels. Insures trouble-free operation in salt air environments allowing the doors to operate easily and quietly.



This results in a wheel that tracks perfectly without lateral vibration and contributes significantly to the ease and smoothness of operation...
Better Roller Systems

Muntins*: Inside and outside muntins enhance the design. Internal muntins available for insulated glass panels.

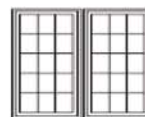

Color Finishes:



White & Bronze also available in South Beach Silver Clear Anodized 215 Class 1. AAMA 2603, 2604* and 2605 - Custom Color Match Finishes always available.

Screens Option: Featuring as our standard screen option. Heavy-duty exterior screen with frame depth of 1-1/4" x 2-5/8". Featuring adjustable stainless steel housed 1-5/8" Delrin® wheels.

SILL RISER OPTIONS

Whatever the demands of your specific location, we can provide the sill riser to handle the rain. (See the chart below.)

Offers 3 Different Blade Sill Riser Heights

Sill Riser Height	Lab Results
2- 1/2"	9.0 psf
3- 1/8"	12.0 psf
4- 1/4"	18.0 psf

Offers 3 Different Blade Track/Sill Options.

2-Track sill depth = 3- 9/16"



3-Track Sill Depth = 5- 1/2"

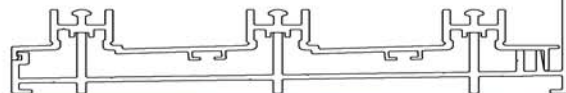

4-Track Sill Depth = 7- 1/2"

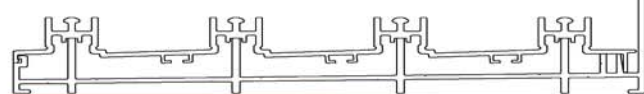

www.WinDoorInc.com



WinDoor®

HIGH PERFORMANCE DOORS & WINDOWS

8100 Series

Sliding Glass Door Aluminum

Featuring: 2 - 3 - 4 & 5 Track Sliding Glass Door Systems

Unlimited Number Of Panel Configurations available in Pocket, Bypass and 90 Degree and 135 Degree Corner Systems



Offering two different bottom rails sizes ...
(Standard bottom 5 inches tall) or shown here our optional
(High bottom rail at 8-5/8") That will also match the sight-lines
for our Fixed Window and
Terrace Door
system.



**8100 Series Impact & Non-Impact
Sliding Glass Door Design Pressures**
DP's Up To +125 / -150

BIG Max Panel Size:
5 Feet x 12 Feet Tall Panels
Water Performance up to 18 lbs
Single or Double Glazed Options
U-Factor as Low as 0.63
SHGC as Low as .20

**The Perfect Sliding Glass Door for
Residential or Commercial Projects...**



Up To 12 Feet Tall

www.WinDoorInc.com

More Highlights On The Back



Thin Is In...

The "New Narrow Interlock" for the 8100 Series Sliding Glass Door, brings a new "Contemporary Style" to your design capabilities.

The "New Narrow Interlock" allows you to enjoy an enhanced view by introducing a **2 Inch Wide Interlock** that achieves the same overall performance as the "Original 4-5/8 Interlock" that made the WinDoor 8100 Series the most preferred sliding glass door in the "High Velocity Hurricane Zone" Market.

8100 Series Impact-Resistant Glazing: Featuring Hurricane Or Safety Protection Glass. Large and Small Missile 9/16" single glazed and 1" insulated glass. Protects against damage caused by windborne debris or intruders. Eliminates the need for unsightly and inconvenient storm shutters. Non Impact Glazing: Tempered glass from 3/16" up to 1" insulated glass for locations not requiring impact glazing.

We have two rows of INTERLOCKS that have been incorporated into our jambs so they combine to form one very strong element. The interlocks assure that the panels actually lock together to resist any force that is placed upon them. This feature was designed to withstand pressures created by the hurricane winds.

Custom-Matched Colors: Custom Paint can be matched to the color of any décor, We can even provide you with two different colors Inside & Out!

Standard Roller Systems: Our Engineers have specifically designed adjustable tandem rollers with 3" Delrin® wheels by Dupont with stainless steel housings and stainless steelball-bearings that allows the doors

to operate easily and quietly. The wheel has been designed so that it's contoured to perfectly match the aluminum track it rides on. This results in a wheel that tracks perfectly without lateral vibration and contributes significantly to the ease and smoothness of operation....
Better Roller Systems

and stainless steelball-bearings that allows the doors to operate easily and quietly. The wheel has been designed so that it's contoured to perfectly match the aluminum track it rides on. This results in a wheel that tracks perfectly without lateral vibration and contributes significantly to the ease and smoothness of operation....

Locking Systems Anti-Slam:
Adjustable stainless steel dual-point mortise locks...
Secondary locking system available, exterior key lock available as well.

Muntins*: Inside and outside muntins enhance the design. Internal muntins available for insulated glass panels.

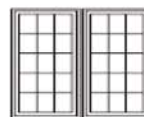

The standard handle is our aluminum Signature Series Shown here - with an optional choice of the The Euro & The Contemporary Series - Other Handle Options can be seen on-line.



Screens Option: Featuring as our standard screen option. Heavy-duty exterior screen with frame depth of 1-1/4" x 2-5/8". Featuring adjustable stainless steel housed 1-5/8" Delrin® wheels.

5- SILL RISER and 5-TRACK OPTIONS

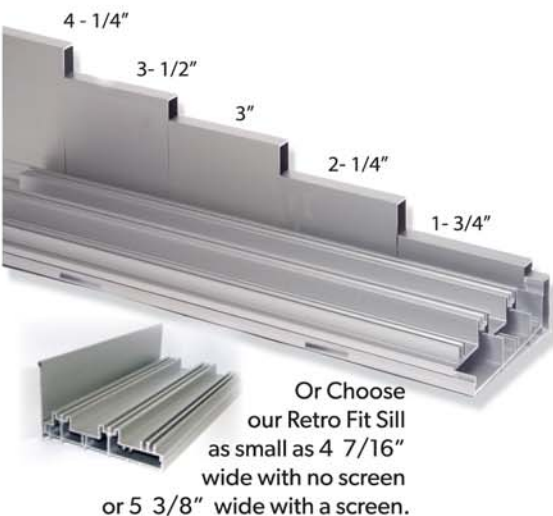

Or Choose our Retro Fit Sill as small as 4 7/16" wide with no screen or 5 3/8" wide with a screen.

The performance data is from laboratory tests Controlling water with a variety of sill riser heights

Sill Riser Height	Certified Test Lab Results
1- 3/4"	6.0 psf
2- 1/4"	9.0 psf
3"	12.0 psf
3- 1/2"	15.0 psf
4- 1/4"	18.0 psf

All products meet Miami Dade and AMMA protocols and are tested in accredited laboratories complying with third party certification.



2-Track sill depth = 5- 1/8"

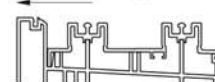

3- Track sill depth = 7- 1/2"

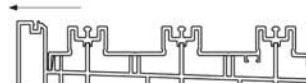

4- Track sill depth = 9- 7/8"

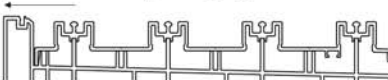

5- Track sill depth = 12- 1/4"

